

REVISIONS			
LTR	DESCRIPTION	DATE	APPROVED

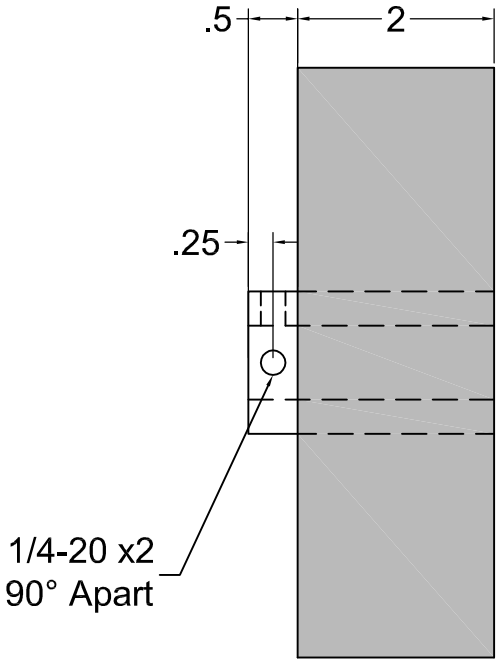

<b>Durometer Options</b>	
Replace <b>XXX</b> in Part Number with 3 letter durometer code from options below.	
<b>40A</b> = 40 SHORE A	<b>80A</b> = 80 SHORE A
<b>55A</b> = 55 SHORE A	<b>90A</b> = 90 SHORE A
<b>70A</b> = 70 SHORE A	

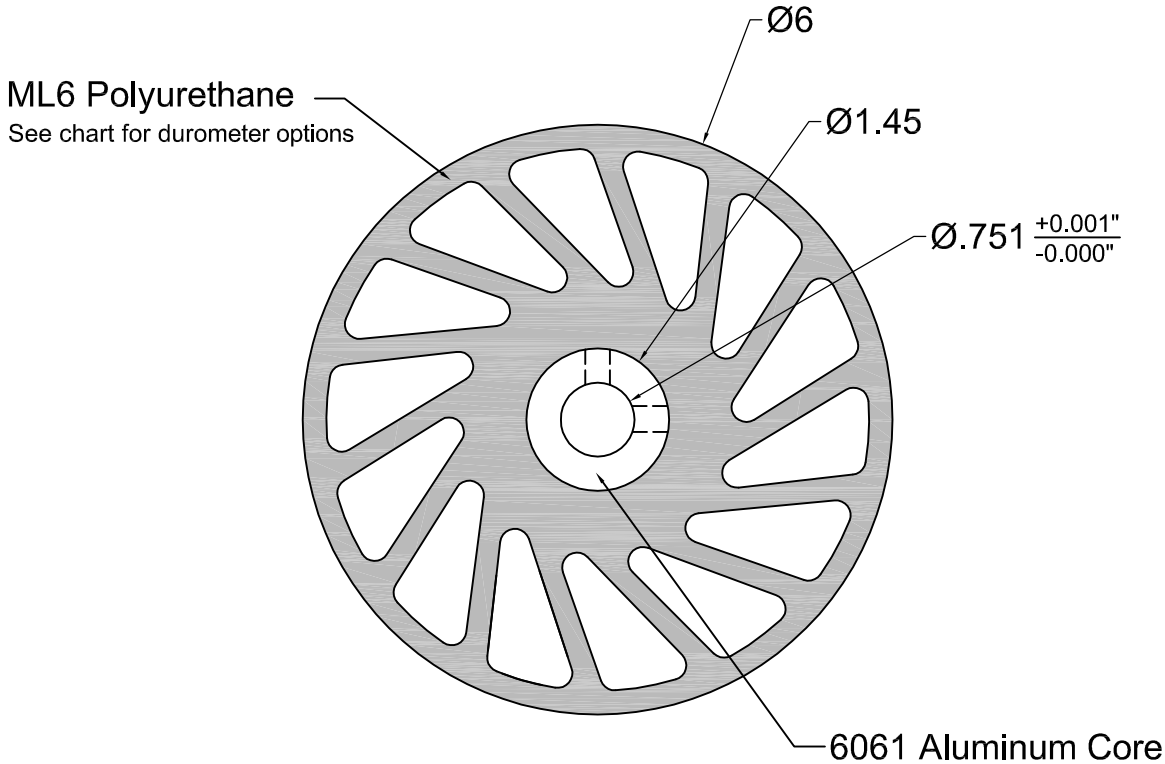

**MERIDIAN  
LABORATORY**

2415 Pleasant View Rd. Middleton, WI 53562  
(608) 836-7571 MeridianLab.com

UNLESS OTHERWISE SPECIFIED,  
DIMENSIONS ARE IN INCHES AND  
TOLERANCES ARE:

FRACTIONS	DECIMALS	ANGLES
±1/16	.X ± .1	±1/2°
	.XX ± .01	
	.XXX ± .005	

PROJECTION

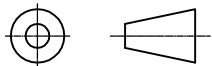

APPROVALS

DATE

DRAWN

AG

2/8/23

CHECKED

VRN

2/23/23

APPROVED

TITLE

6.0" x 2.0" ML6 NO-CRUSH WHEEL

PART NO.

NCW-620-XXX

MATERIAL

6061 AL & ML6 PU OVERMOLD

SCALE 2:1

REV. -

SHEET 1 of 1

ML6 CUST. BLOCK

This drawing is proprietary to Meridian Laboratory Inc. and may not be copied, disclosed, or distributed without explicit written permission. Design subject to change without notice.