

REVISIONS			
LTR	DESCRIPTION	DATE	APPROVED

ML6 Polyurethane
See chart for durometer options

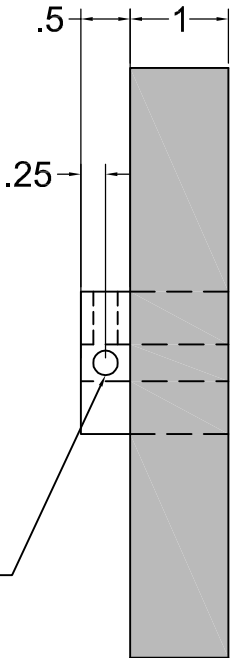
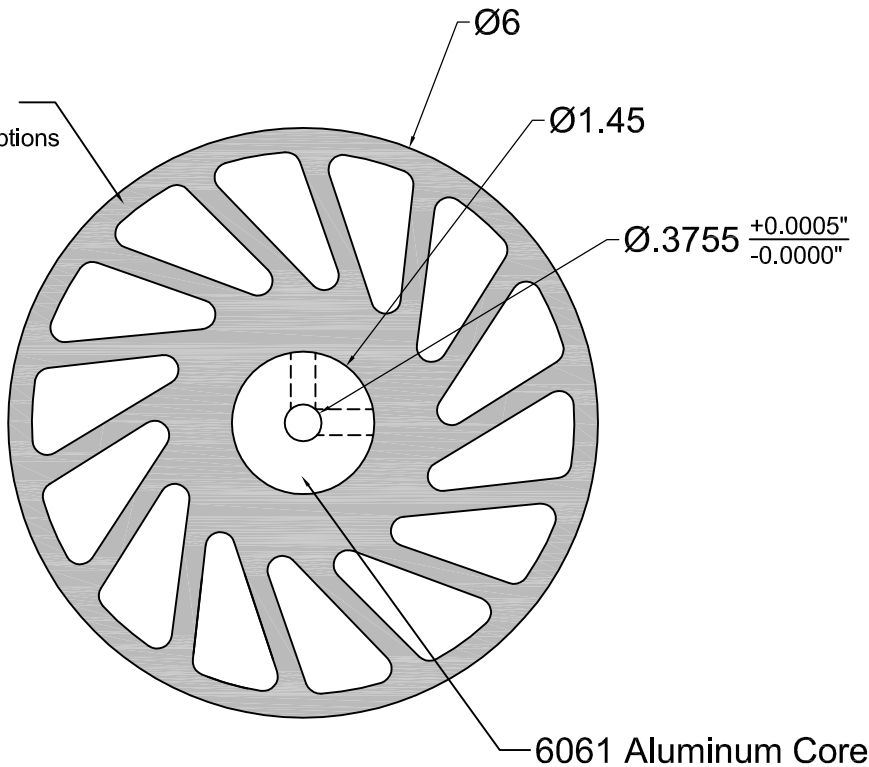

1/4-20 x 2
90° Apart

Durometer Options	
Replace XXX in Part Number with 3 letter durometer code from options below.	
40A = 40 SHORE A	80A = 80 SHORE A
55A = 55 SHORE A	90A = 90 SHORE A
70A = 70 SHORE A	



**MERIDIAN
LABORATORY**

2415 Pleasant View Rd. Middleton, WI 53562
(608) 836-7571 MeridianLab.com

UNLESS OTHERWISE SPECIFIED,
DIMENSIONS ARE IN INCHES AND
TOLERANCES ARE:
FRACTIONS DECIMALS ANGLES
±1/16 .X ±.1 ±1/2°
.XX ±.01
.XXX ±.005

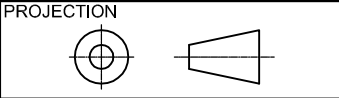

APPROVALS	DATE
DRAWN AG	2/8/23
CHECKED VRN	2/23/23
APPROVED	

TITLE 6.0" x 1.0" ML6 NO-CRUSH WHEEL			
PART NO. NCW-540-XXX			
MATERIAL 6061 AL & ML6 PU OVERMOLD			
SCALE 2:1	REV. -	SHEET 1 of 1	ML6 CUST. BLOCK

This drawing is proprietary to Meridian Laboratory Inc. and may not be copied, disclosed, or distributed without explicit written permission. Design subject to change without notice.