

REVISIONS			
LTR	DESCRIPTION	DATE	APPROVED

ML6 Polyurethane  
See chart for durometer options

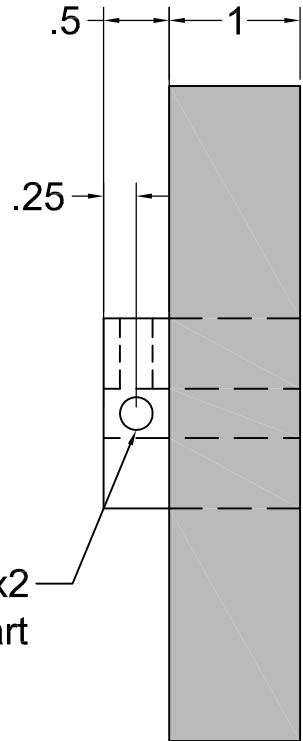
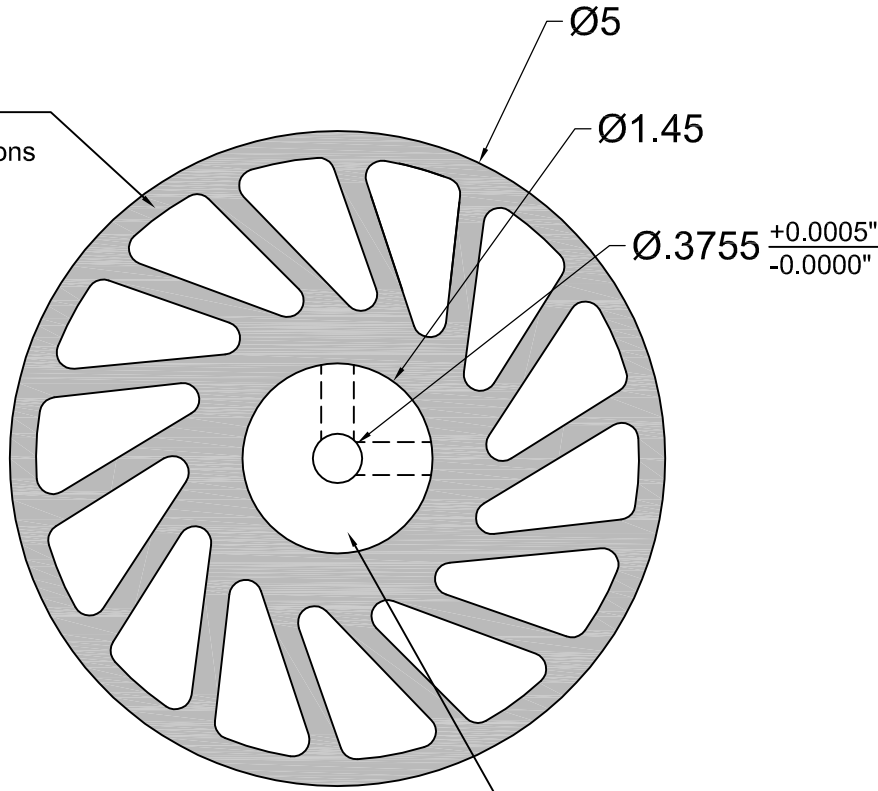

1/4-20 x2  
90° Apart

6061 Aluminum Core

<b>Durometer Options</b>	
Replace <b>XXX</b> in Part Number with 3 letter durometer code from options below.	
<b>40A</b> = 40 SHORE A	<b>80A</b> = 80 SHORE A
<b>55A</b> = 55 SHORE A	<b>90A</b> = 90 SHORE A
<b>70A</b> = 70 SHORE A	



**MERIDIAN  
LABORATORY**

2415 Pleasant View Rd. Middleton, WI 53562  
(608) 836-7571 MeridianLab.com

UNLESS OTHERWISE SPECIFIED,  
DIMENSIONS ARE IN INCHES AND  
TOLERANCES ARE:  
FRACTIONS DECIMALS ANGLES  
±1/16 .X ±.1 ±1/2°  
.XX ±.01  
.XXX ±.005

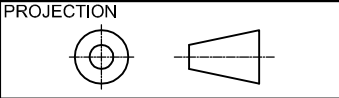

APPROVALS	DATE
DRAWN <b>AG</b>	<b>2/8/23</b>
CHECKED <b>VRN</b>	<b>2/23/23</b>
APPROVED	

TITLE	<b>5.0" x 1.0" ML6 NO-CRUSH WHEEL</b>		
PART NO.	<b>NCW-440-XXX</b>		
MATERIAL	<b>6061 AL &amp; ML6 PU OVERMOLD</b>		
SCALE	<b>3:2</b>	REV.	<b>-</b>
SHEET	<b>1 of 1</b>	ML6 CUST. BLOCK	

This drawing is proprietary to Meridian Laboratory Inc. and may not be copied, disclosed, or distributed without explicit written permission. Design subject to change without notice.